



Model 2009 3" Stroke, Two Handle Push Pull Control Head

This control is available with three different handles; standard, handles with plastic grips or curved handles with knobs. An optional clutch and throttle interlock can be ordered with this unit. The purpose of this interlock is to prevent shifting, above engine idle. It is only available for systems having clutch and throttle on the same control. In two station applications only one interlock is required. For gears with an electric clutch, an adapter with two electric clutch, and adapter with two microswitches can be ordered.

Features

- 5 year guarantee
- Corrosion free die cast silicon bronze and stainless steel hardware
- 3 adjustable stroke ranges up to 3 inches
- Suitable for 30 Series and 40 Series Cables
- LARGE CENTER BEARING
- No Lost Motion
- High strength
- Low Wear and Long Life
- Removable dome for easy head and cable installation
- Independent friction and detent (standard) are adjustable and removable
- Operating quadrants are positively pin fastened to handle shaft for safety
- Suitable for series or parallel rigging
- Optional safety switch, which prevents engine starting unless control head is in neutral (center) position, is available either pre-installed or in kit form
- Self-adhesive labels, instructions and a cutout template are included

Ordering Information

Model Designations:

A	One short handle with friction and one long handle with detent	I	Electric clutch adaptor
AA	One short handle with friction and one long handle with friction	*J	With two neutral safety switches
B	Two long handles with detent	K	With chrome finish cover and handles
C	Two long handles with friction	L	With polished brass finish cover and handles
D	Two long handles with one detent and one friction	M	With black epoxy finish cover and chrome handles
E	Two short handles with detent	S	R.H. Model with interlock (gear on right side)
F	Two short handles with friction	T	L.H. Model with interlock (gear on left side)
G	Two short handles with one detent and one friction	U	With curved handles and red or black knobs
*H	With one neutral safety switch	V	With red or black plastic grips

* Neutral Safety switch is normally installed with detented handle.

The standard Model 2009 control head is supplied as follows:

1. One short handle with friction and one long handle with detent
2. With chrome finish cover and handles
3. Without neutral safety switch

To order, state Model Number followed by the desired Model Designation letter codes:

Example

Standard 2009 control head. Ordering No. is 2009 AK

Note

Cable connector kits are ordered separately. Each Push Pull cable end attached to the control head requires one kit.

Ordering Numbers

2009 - 0901 Connection Kit (30 series cable)
2009 - 0903 Neutral Safety Switch Kit

2009 - 0902 Connection Kit (40 series cable)
2009 - 0910 Electric Clutch Adaptor Kit

Weight

6 lb. (2.73 kg.)

Patents

U.S. Patent Number 4280371

CAN. Patent Number 1158136

Dimensions and Parts

Side View

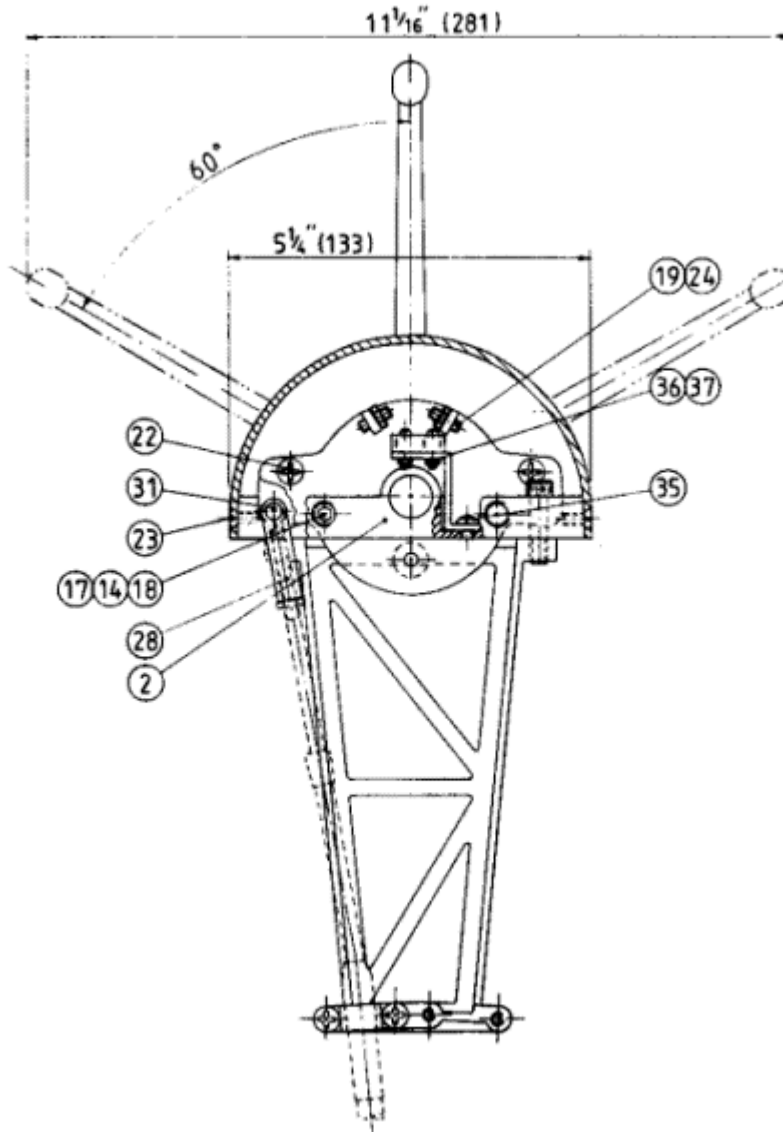

ALL DIMENSIONS IN INCHES (MM)

ITEM	QUANTITY	PART NUMBER	DESCRIPTION
2	1	2009-0002	Frame
14	*1	2009-0011	Detent Pin
17	*1	1201-0003	Spring
18	2	1016-1204	Setscrew
19	4	1016-0808	Setscrew
22	4	1009-0808	Flat Hd. Screw
23	2	1005-0808	Oval Hd. Screw

Model 2009 3" Stroke Two Handle Push Pull Control Head

24	4	1022-0108	Nut
----	---	-----------	-----

2009-0901 (30 SERIES) CONNECTION KIT

28	1	2105-0001	Clevis
31	1	1037-0410	Pin

2009-0902 (40 SERIES) CONNECTION KIT

28	1	2105-0002	Clevis
31	1	1037-0410	Pin

2009-0903 NEUTRAL SAFETY SWITCH KIT

35	1	1010-0804	Round Hd. Screw
36	2	1004-0208	Round Hd. Screw
37	2	1022-0102	Nut

* Quantity may vary.

Front View

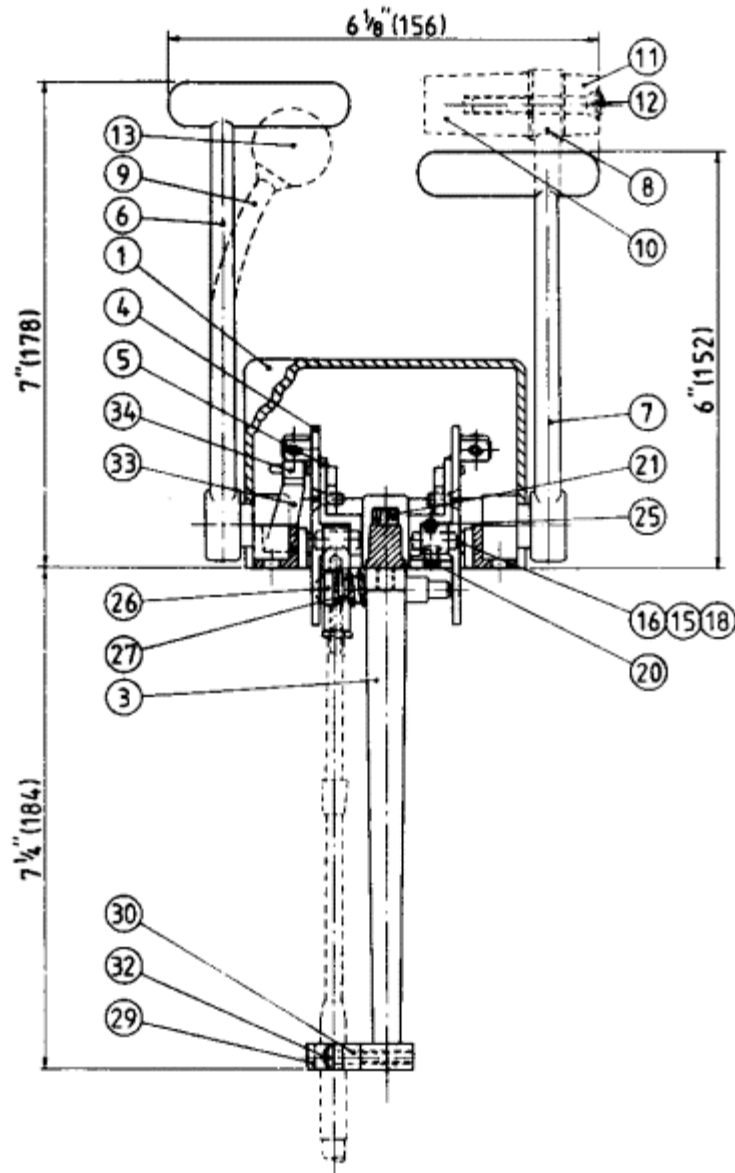

ALL DIMENSIONS IN INCHES (MM)

ITEM	QUANTITY	PART NUMBER	DESCRIPTION
1	1	2009-0001	Dome
3	1	2009-0003	Support
4	1	2009-0004A	Pivot Plate (Three Detents)
4	1	2009-0004B	Pivot Plate
5	2	2009-0005	Pin Retainer

Model 2009 3" Stroke Two Handle Push Pull Control Head

6	*1	2009-0015	Long Handle (Standard)
7	*1	2009-0016	Short Handle (Standard)
8	*1	2009-2015	Long Handle (Plastic Grips)
8	*1	2009-2016	Short Handle (Plastic Grips)
9	*2	2009-3015	Curved Handle (Knobs)
10	*1	2111-0001B	Plastic Grip (Black)
10	*1	2111-0001R	Plastic Grip (Red)
11	*1	2111-0004B	Grip End (Black)
11	*1	2111-0004R	Grip End (Red)
12	*2	1011-1028	Oval Hd. Screw
13	*1	2030-0011	Black Knob
13	*1	2030-0012	Red Knob
15	*1	2542-0008	Friction Pad
16	*1	1201-0002	Spring
18	2	1016-1204	Setscrew
20	2	1016-0804	Setscrew
21	2	1002-1016	Socket Hd. Screw
25	2	1024-0816	Spring Pin

OPTIONAL INTERLOCK

26	1	2009-0014	Interlock Pin
27	1	1201-0005	Spring

2009-0901 (30 SERIES) CONNECTION KIT

29	1	2108-0001	Clamp
30	1	2109-0002	Spacer
32	2	1010-0808	Round Hd. Screw

2009-0902 (40 SERIES) CONNECTION KIT

29	1	2108-0002	Clamp
30	1	2109-0002	Spacer
32	2	1010-0814	Round Hd. Screw

2009-0903 NEUTRAL SAFETY SWITCH KIT

33	1	2011-0007	Bracket
34	1	1901-0001	Microswitch

* Quantity may vary.

2009 "Cut-Out" Dimensions

